

New Al-7%Mg Welding Electrode for Crackless Welding of Al-Zn-Mg(7NO1) High Strength Aluminum Alloy (Report I) †

— Investigation on Weld Solidification Crack Susceptibility —

Kazuhiro NAKATA *, Yoshiaki MIYANAGA**, Fukuhisa MATSUDA***, Kenji TSUKAMOTO****
and Khozho ARAI ****

Abstract

The metallurgical investigations on the effects of Mg and Zn contents in weld metal in Al-Zn-Mg system on the solidification cracking susceptibility have been carried out in order to develop a new welding wire having low susceptibility for solidification cracking in GMA weld metal of 7NO1. An Al-7%Mg welding wire made experimentally has proved to be an excellent welding wire for the improvement of the resistance to solidification cracking in weld bead and crater during GMA welding of 7NO1.

KEY WORDS: (MIG Welding) (Al-Zn-Mg Alloy) (Solid Filler Wire) (Hot Cracking) (Casting)

1. Introduction

Recently, 7NO1 (Al-4.5%Zn-1.2%Mg) alloy begins to be used as the components for the welding constructions, especially railroad vehicles, because this alloy processes high yield strength and good natural age-hardenability in fusion zone and HAZ after welding and also can be easily manufactured as the extruded material with various shape.

It is also known, however, that susceptibility of this alloy for solidification cracking during welding is much higher than that of 5083 (Al-4.5%MgMn) alloy which has been widely used as the component for large welding constructions such as the LNG storage tank. Therefore, in order to lower the cracking susceptibility during welding, 5356 (Al-5%Mg) and 5183 (Al-4.5%MgMn) alloys have been widely used as a welding wire in GMA welding of 7NO1 in spite of fairly loss in strength of weld metal. Nevertheless, in actual GMA welding process under the condition that weld components are highly restrained, solidification cracking often occurs in the welds, especially in the weld starting and crater zones in spite of the use of these low cracking susceptible welding wires. This is one of the reason why 7NO1 alloy is not so widely used as the material for the welding production as 5083 alloy is.

Therefore the aim of this report is to develop a new welding wire having high resistance to solidification cracking during GMA welding of 7NO1 alloy.

It is well known that cracking susceptibility of GMA weld metal of 7NO1 alloy closely depends on Zn and Mg contents in weld metal¹⁾²⁾ which are considerably changed by the mixing ratio of compositions between base metal and welding wire. According to the authors' chemical analysis of various weld metals of 7NO1 alloy which was actually welded with 5356 or 5183 welding wire by GMA process, most of weld metals fell in 1 to 3% in Zn and 2.5 to 4% in Mg³⁾. Therefore, at first, the effect of Mg for the solidification cracking has been investigated under three levels of 1, 2 and 3%Zn by using the ring-cast cracking test⁴⁾ and GTA spot weld cracking test in order to make clear the composition of GMA weld metal having high resistance to solidification cracking. Secondary, a new welding wire has been manufactured experimentally so that the composition of GMA weld metal of 7NO1 with this welding wire became into the special range of the composition recommended in the above. Then, the cracking susceptibility of GMA welds of 7NO1 with a new welding wire has been evaluated by the GMA weld crater cracking test and the VDR cracking test⁵⁾ in comparison with other some commercial welding wires.

† Received on September 24, 1980

* Research associate

** Graduate student of Osaka Univ. (Presently, Hitachi, Ltd.)

*** Professor

**** Showa Aluminium Corporation

Transactions of JWRI is published by Welding Research Institute of Osaka University, Suita, Osaka, Japan

2. Experimental Procedure

2.1 Materials used

Master alloys whose chemical compositions are shown in **Table 1** are used for the ring-cast cracking test. These master alloys were experimentally manufactured by using commercially used pure Al(99.8%), Mg(99.9%) and Zn (99.9%), which were melted in graphite crucible by electric furnace at 750°C and after sufficient degassing process with C_2Cl_6 , were casted into the mould made by mild steel. A little amount of Fe and Si were contained as impurities, but these were almost the same values as those contained in commercial Al alloys as shown in **Table 2**.

Table 1 Chemical compositions of materials used for ring-cast cracking test.

Material	Chemical composition (wt%)			
	Si	Fe	Mg	Zn
Al-1%Zn	0.04	0.11	-	1.0
Al-2%Zn	0.04	0.19	-	2.0
Al-3%Zn	0.04	0.12	-	3.0
Al-12%Mg	0.07	0.11	11.0	-
Al-12%Mg-1%Zn	0.07	0.11	12.0	1.0
Al-12%Mg-2%Zn	0.07	0.11	11.4	1.8
Al-12%Mg-3%Zn	0.07	0.11	11.8	2.9
Al-1%Mg-30%Zn	0.07	0.11	0.95	31.0

Table 2 Chemical compositions of materials used for GMA welding

Material		Chemical composition (wt %)								
		Cu	Si	Fe	Mn	Mg	Zn	Cr	Ti	Zr
Base metal	5083-0	0.02	0.15	0.19	0.64	4.49	-	0.11	0.017	-
	7N01-T4	Tr.	0.07	0.17	0.44	1.15	4.50	0.22	0.02	0.17
Welding wire	7N11	0.01	0.06	0.12	0.34	4.15	1.96	-	0.07	-
	5183	0.01	0.10	0.19	0.60	4.87	0.02	0.08	0.07	-
	5356	0.01	0.06	0.19	0.14	4.95	0.01	0.11	0.11	-
	Al-7%Mg	0.01	0.05	0.18	0.12	6.96	0.01	0.10	0.09	-

Table 2 shows the chemical compositions of base metals and welding wires used for weld cracking tests with GMA welding. Plate thickness of base metal is 12 and 15 mm for 7N01 and 5083, respectively, and diameter for each welding wire is 1.6 mm. Among welding wires, a Al-7%Mg alloy is a new welding wire experimentally manufactured in this study and others are commercially used ones.

2.2 Cracking test

2.2.1 Ring-cast cracking test

It is well known that the ring-cast cracking test is one of the most common and convenient solidification cracking tests for Al alloys, because the composition of test alloy can be easily changed to intended composition and its testing apparatus is a simple and compact.

Therefore, effects of Mg and Zn contents on susceptibility for solidification cracking have been evaluated by the ring-cast cracking test. A testing apparatus is shown in **Fig. 1**. Test alloy which was arranged to the adequate amounts of Mg and Zn was melted in a graphite crucible (2) in argon atmosphere by using electric furnace(1) and poured into a mould(5) as shown in **Fig. 2** from 750°C at the temperature of the melt. The mould was preheated at

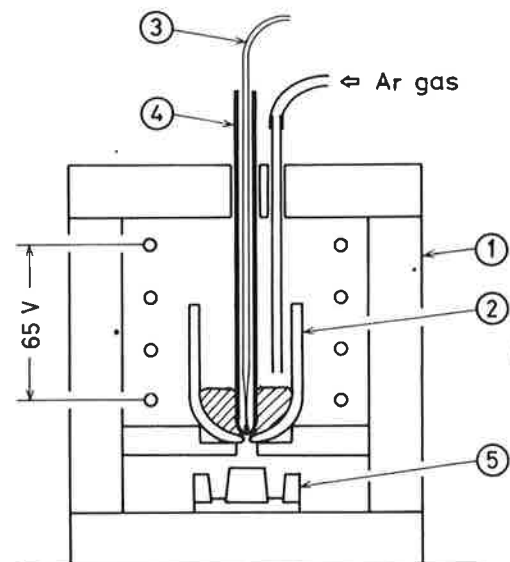

Fig. 1 Equipment of ring-casting test. (1) electric furnace, (2) graphite crucible, (3) PR thermocouple, (4) stopper (protective tube for thermocouple), (5) mould.

50°C. After the casting was cooled to room temperature, it was removed from the mould and the lengths of cracks observed on the surface of a specimen were measured. The

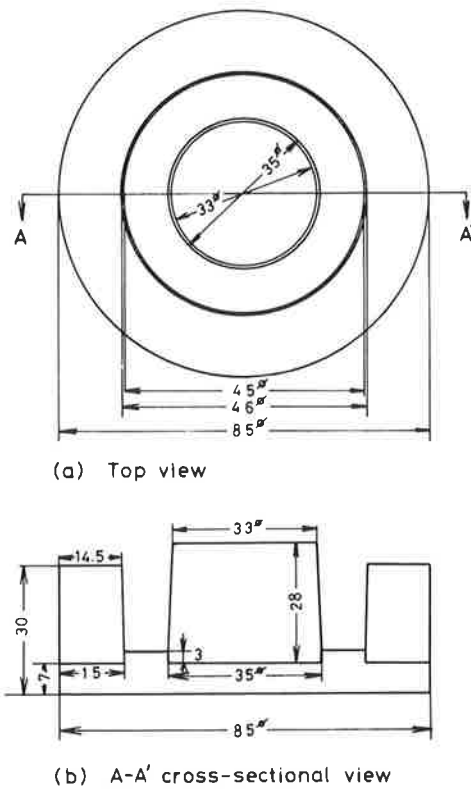

Fig. 2 Shape and size of mould for ring-casting.

number of repeat of cracking test is at least five. The solidification crack susceptibility was evaluated by the mean value of the total crack lengths of specimens. A typical appearance of ring-casted specimen is shown in Fig. 3. The Zn content of the specimen was decided to be

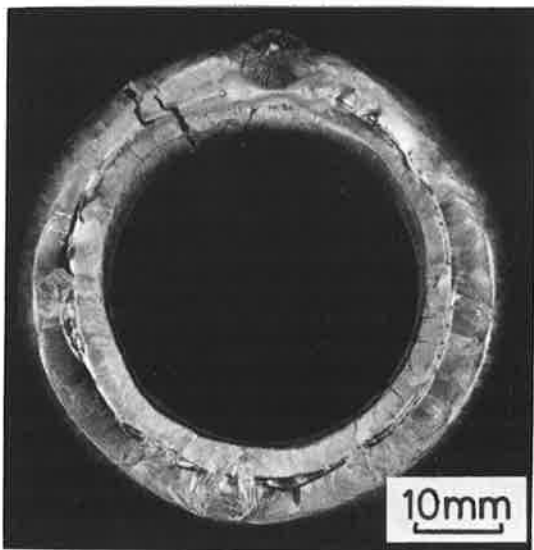

Fig. 3 Typical appearance of ring-casting of 7N01.

almost the same values as that of GMA weld metal of 7N01 with 5356 welding wire, that is, 1, 2 and 3%. In order to examine the effect of Mg content, it was widely changed from zero to 10% in each Zn content.

2.2.2 GTA spot weld crater cracking test

In order to examine the effects of Mg and Zn on the susceptibility of weld crater cracking, the weld crater was made directly on the ring-casted specimen as shown in Fig. 4 by performing the spot welding with gas-tungsten arc (GTA) in DCSP on its surface with a constant welding condition, that is, 120 amp of welding current, 15~17 volt of arc voltage and 4 seconds of arc time. The number of weld craters was three for each specimen. The lengths of cracks observed on the surface of the weld crater were measured. The susceptibility of the weld crater cracking was evaluated by the ratio of the total-length of cracks to mean diameter of the welding crater.

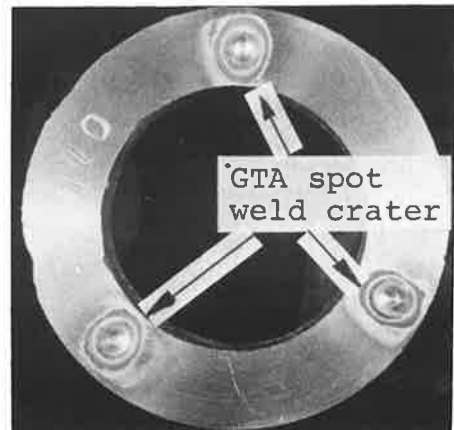

Fig. 4 Appearance of specimen tested by GTA spot weld crater cracking test on ring-casting.

2.2.3 GMA weld crater cracking test

The crater cracking susceptibility in actual GMA weld crater of 7N01 was examined with 7N11 and 5356 commercial welding wires and also Al-7%Mg experimentally manufactured welding wire. Three short weld beads of about 60 mm in length were discontinuously made on a vee-grooved specimen as shown in Fig. 5. The welding conditions are 220~230 and 270~280 amp of welding current and 200, 400 and 600 mm/min of welding speed for each welding current. The crater cracking susceptibility was evaluated by the ratio of the total-length of cracks observed on the surface of the weld crater to maximum length of the weld crater.

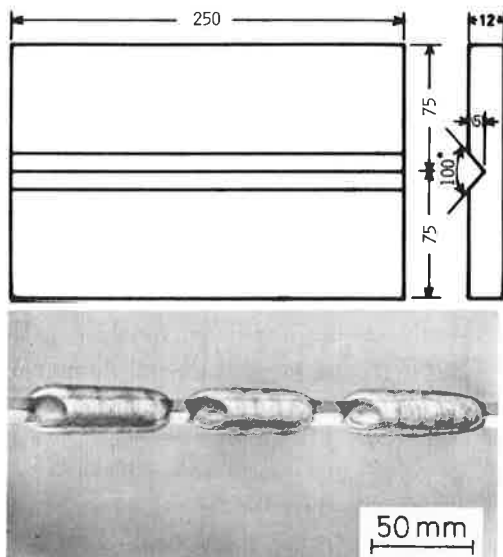

Fig. 5 Dimensions and appearance of specimen for GMAW crater cracking test.

2.2.4 The VDR cracking test

The solidification crack susceptibility of the GMA weld metal of 7N01 with new welding wire of Al-7%Mg was evaluated by the VDR cracking test in comparison with commercial welding wires of 7N11 and 5356 and also 5083 base metal with 5183 welding wire. In this cracking test, which was developed by the authors⁵⁾, two criteria for the evaluation of the solidification crack susceptibility, that is, the critical deformation rate for crack initiation at weld starting zone (\dot{D}_{CI}) and for crack propagation during welding (\dot{D}_{CP}) were quantitatively measured by deforming the solidifying weld metal during welding with various rate of deformations. Cracking susceptibility of weld metal decreases with the increase in the value of these criteria. In this report the \dot{D}_{CI} is mainly used because \dot{D}_{CI} is more sensitive than \dot{D}_{CP} for solidification cracking in weld metal. The GMA fillet welding was performed as the welding condition of 260~270 amp of welding current, 29~31 volt of arc voltage and 400 mm/min of welding speed.

3. Experimental Results and Discussions

3.1 Determination of desirable compositional range of Mg and Zn in weld metal having an excellent resistance to solidification cracking

3.1.1 Results of ring-cast cracking test

Effects of Mg and Zn contents on the total-crack length are shown in Fig. 6 where the total-crack lengths of 5083 and 7N01 are also represented with bold lines in the right side of the figure. It is clear that the total-crack length mainly depends on Mg content. The total-crack

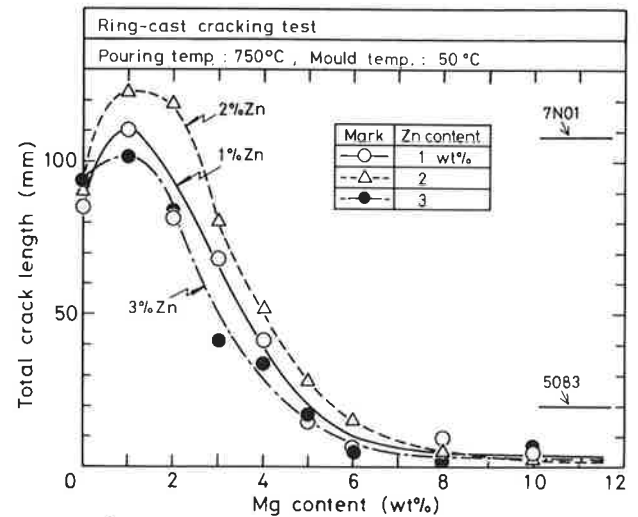

Fig. 6 Effect of Mg content on total-crack length in various Zn contents.

length showed its maximum value around 1% Mg content and it was drastically decreased as the increase in Mg content, especially at more than 3% Mg content for each Zn content. Moreover, the total-crack length of 5083 alloy is very low level, that is, 20 mm. This indicates that 5083 alloy possesses very low cracking susceptibility, especially in comparison with 7N01 alloy. In order to lower the cracking susceptibility to the same level as that of 5083, it is considered that more than 5% Mg is required to be contained in weld metal.

On the contrary, only little differences were observed in the total-crack length within the range of 1 to 3% Zn for each Mg content, especially in the range more than 4% Mg. Therefore, Zn is less effective to solidification cracking than Mg as far as Zn content is less than 3%. More Zn content, however, markedly increased the total-crack length under 1% Mg level as shown in Fig. 7. This clearly indicates that Zn content in weld metal should be kept to be less than 3%.

3.1.2 Results of GTA spot weld crater cracking test

In welding of Al-Zn-Mg alloy such as 7N01, solidification cracking is likely to occur particularly in weld crater. Therefore, Effects of Mg and Zn contents on cracking susceptibility in weld crater have been examined with GTA spot weld cracking test. Results are shown in Fig. 8. The crater cracking susceptibility was evaluated by a formula indicated in figure. Effects of Mg and Zn contents on the weld crater cracking were almost as same as those in the ring-cast cracking test shown in Fig. 6. Taking cracking susceptibility of 5083 into considerations, more than 4% Mg is required to be contained in weld metal in order to obtain enough resistance to weld crater cracking.

Judging from the results of Fig. 6, 7 and 8, it is considered that the Mg content in weld metal is required to be more than 5% in order to lower the cracking susceptibility of GMA welds of 7N01 to the same or less level of that of 5083.

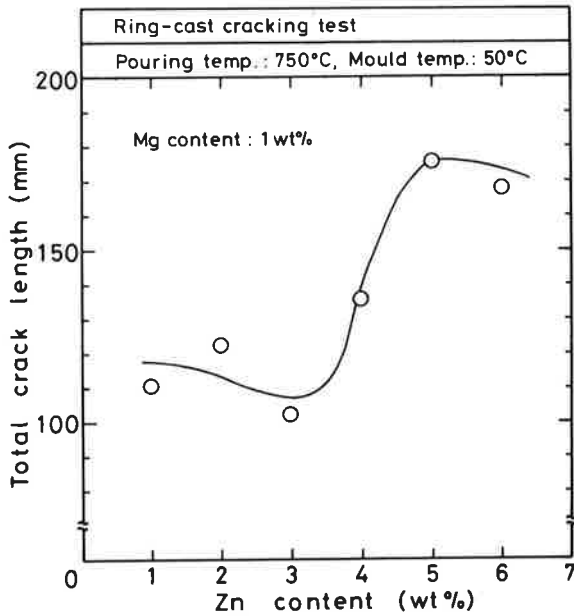

Fig. 7 Effect of Zn content on total-crack length

3.1.3 Recommendation for desirable composition of welding wire for GMA welding of 7N01 alloy

Desirable Mg and Zn contents for a new welding wire were discussed on a cracking diagram shown in Fig. 9 which showed the combined effects of Mg and Zn on cracking susceptibility represented by total-crack length in mm in ring-cast cracking test. This cracking diagram qualitatively agreed with the reports⁶⁾⁷⁾.

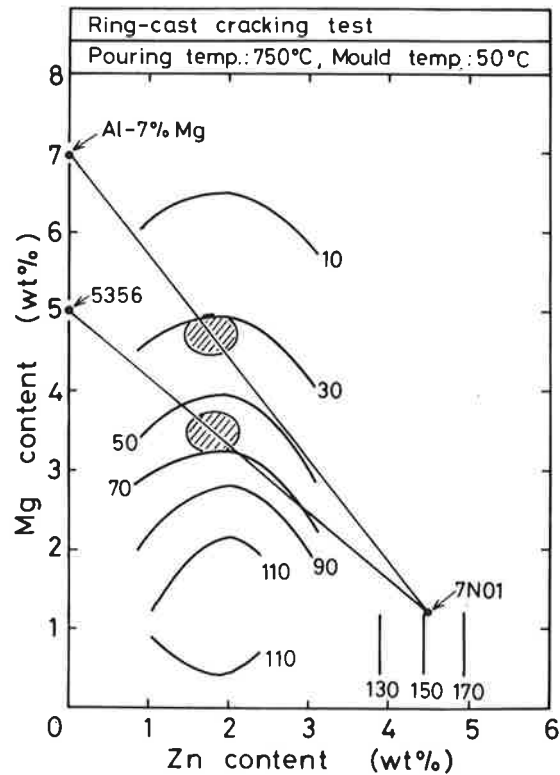

Fig. 9 Estimation of cracking susceptibility of GMA weld metal using 5356 and Al-7% Mg welding wires from cracking diagram measured by ring-casting test (the number in figure shows total-crack length in mm).

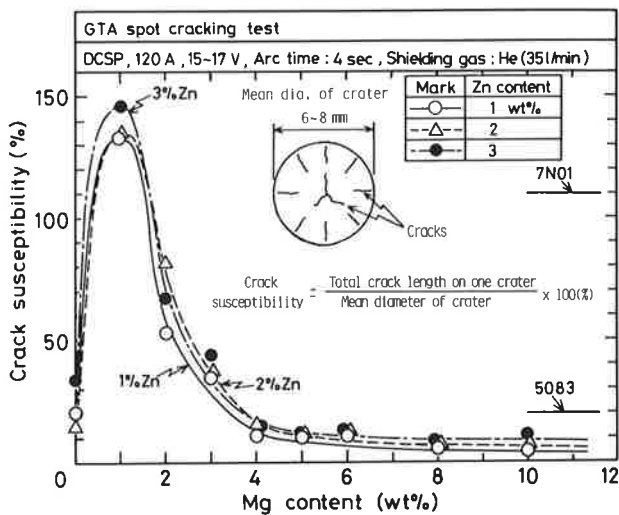

Fig. 8 Effect of Mg content on cracking susceptibility evaluated by GTA spot weld crater cracking test for various Zn contents.

As to Zn content of welding wire, Al-Mg binary alloy without Zn is desirable because Zn aggravates the cracking at more than 4% and Zn content in weld metal should be kept to be less than 3%.

In actual GMA welding, the ratio of the composition of welding wire diluted by that of base metal is about 20 to 70%, mostly around 40%. As GMA welding of 7N01 with 5356 wire, it is difficult to increase Mg content in weld metal to be more than 4%, because this requires very low ratio of dilution such as less than 20%. Such low ratio of dilution, however, increases the chance to cause the fatal weld defects such as lack of fusion and/or insufficient penetration. Of course, it is impossible to increase Mg content more than 5% which is recommended composi-

tion in 3.1.1. Therefore, to obtain such high Mg content of more than 5%, more than 7% Mg is needed to be contained in the welding wire as shown in Fig. 9.

Consequently, according to the above discussions Al-7%Mg binary alloy, whose chemical compositions were shown in Table 2, was selected as a new welding wire for the GMA welding of 7N01.

3.1.4 Discussions for effect of Mg on solidification cracking

Metallurgical examination has been made on the ring-casted specimen in order to make clear the reason why the cracking susceptibility depended on Mg content as previously mentioned. As the metallurgical factors affecting on the cracking susceptibility, next four factors, that is, grain size, shape and amount of remaining liquid at the last stage during solidification and temperature range of solidification were adopted in this study.

(1) Grain size

Figure 10 shows the macrostructures in cross-sections of the ring-casted specimen for various Mg content. Up to about 2% Mg content, large columnar grains were well developed, but more than 3% Mg, almost all the macrostructures consisted with fine equiaxed grains. Mean grain sizes of these macrostructures which were shown in Fig.11 decreased as the increase in Mg content, then saturated to almost constant value of 300 to 500 μ for all Zn contents. Therefore, it is considered that grain refinement is one of the reason for the decrease in cracking susceptibility as the increase in Mg content.

(2) Shape and amount of remaining liquid

Figure 12 shows the low and high magnification optical microphotographs in ring-casting for various Mg contents. Without Mg and at 1% Mg content, obvious film-like eutectic compounds were mostly observed. Increasing the Mg content to more than 3%, rod-like or globular eutectic compounds became appeared instead of film-like one. In order to make clear quantitatively the change in shapes of these eutectic compounds in grain boundary, the dihedral angle of eutectic compound in grain boundary was measured on as-ring-casted specimens. Accumulation curves for observed dihedral angles are shown in Fig. 13. The medium value at 50% was adopted as the dihedral angle. Up to 1% Mg content, the dihedral angle was very small, that is, 12 degrees. Increasing Mg content to more than 3%, it became large to 29 degrees at 3% and 55 degrees at 5% Mg contents. This means that cracking susceptibility also decreases as the increase in Mg content.

Nextly, amount of eutectic compounds was measured with the point counting methods at x1000 magnification using 400 cross-points eyepiece. Results are shown in Fig. 14. Eutectic compounds gradually increased their

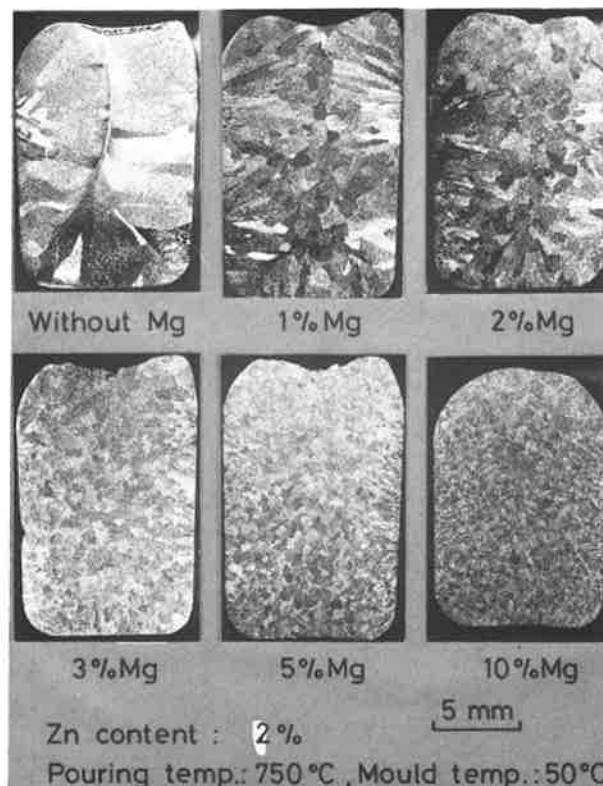

Fig. 10 Effect of Mg content on macrostructures of ring-casting in 2% Zn content.

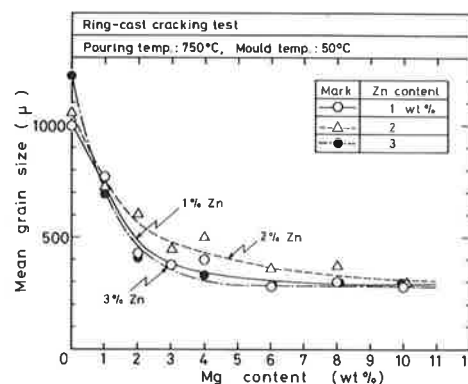

Fig. 11 Mean grain size vs. Mg content in ring-castings.

amounts as the increase in Mg content up to 5%, but remarkable increase was observed at more than 5% Mg content. It is considered that the existence of large amount of remaining liquid at the last stage of solidification, which is represented by eutectic compounds, is beneficial to lower the cracking susceptibility because of the healing effects²⁾⁸⁾.

(3) Solidification temperature range

It is generally known that susceptibility for solidifica-

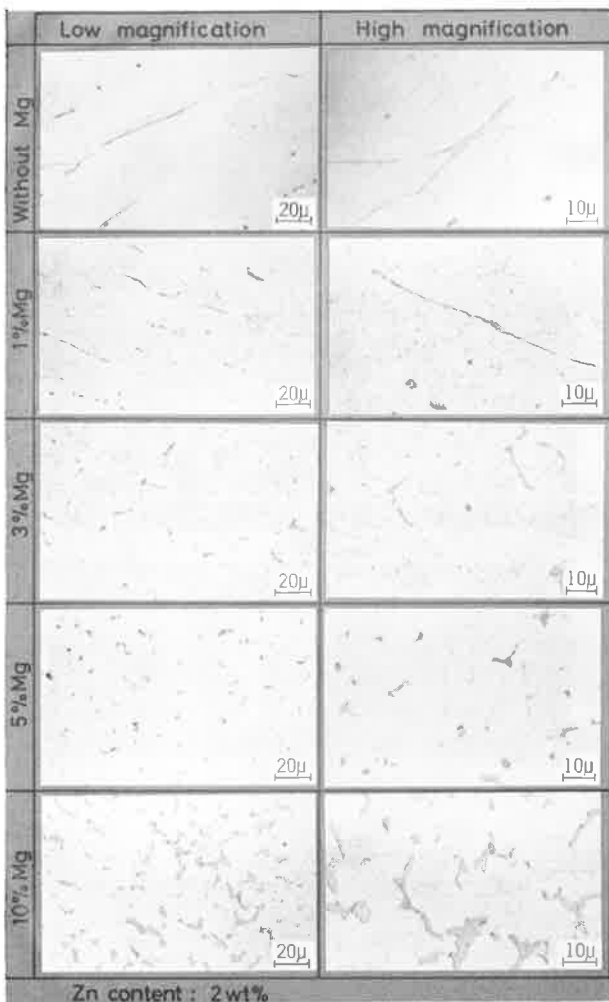

Fig. 12 Microphotographs of eutectic compounds in ring-castings for various Mg contents.

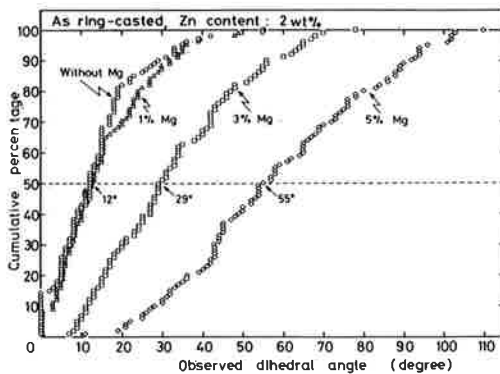

Fig. 13 Accumulation curve for dihedral angle observed in ring-castings for various Mg contents.

casted specimen were melted in graphite crucible in argon atmosphere by using electric furnace and cooled in furnace to measure the cooling curve with Chromel-Alumel thermocouples. Typical examples for cooling curves measured are shown in Fig. 15. Liquidus temperature T_L was gradually lowered as the increase in Mg content. Solidus temperature T_S was also gradually lowered up to 3% Mg content, but at more than 5% Mg content they were drastically lowered to 440-448°C, at which temperature the clear rested points were observed. This lower solidus temperature almost coincides with eutectic temperature due to α (Al) - β (Mg_2Al_3) - τ ($Mg_{32}(Zn,Al)_{49}$) ternary eutectic reaction⁹⁾. These results show that magnesium in alloy increases the solidification temperature range, especially at more than 5%.

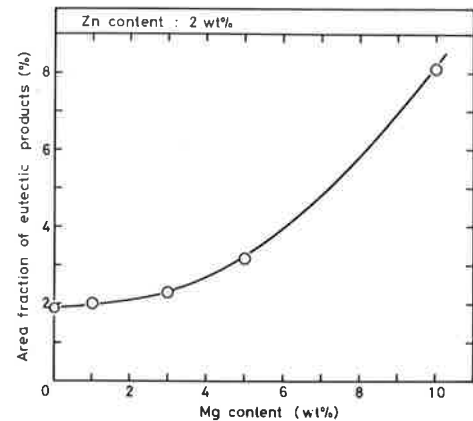

Fig. 14 Area fraction of eutectic compounds in ring-castings for various Mg contents.

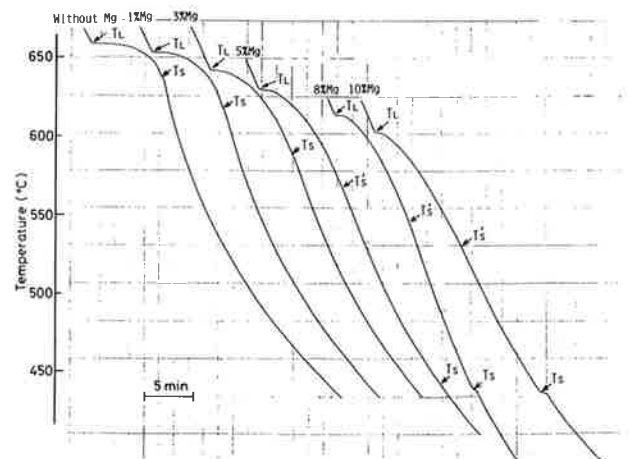

Fig. 15 Cooling curves recorded for various Mg contents in Al-2% Zn alloys with and without magnesium.

tion cracking mostly depends on solidification temperature range where liquid and solid coexist. At first, effect of Mg on solidification temperature range was examined by the thermal analysis. Test specimens cut off from ring-

However, this didn't agree with the result of ring-cast cracking test.

In non-equilibrium solidification at high cooling rate such as welding and casting, it is very difficult to determine the solidus temperature with thermal analysis mentioned in the above except for the alloy having large amount of eutectic compounds. Therefore, next, solidus temperature was estimated from eutectic temperature in phase diagram to determine the compositions of eutectic compounds observed on cracked surface in ring-casted specimen with SEM and the energy dispersive type analyzer (EDX). Typical SEM microphotographs of cracked surfaces are shown in Figs.16 ~ 18 where EDX results for

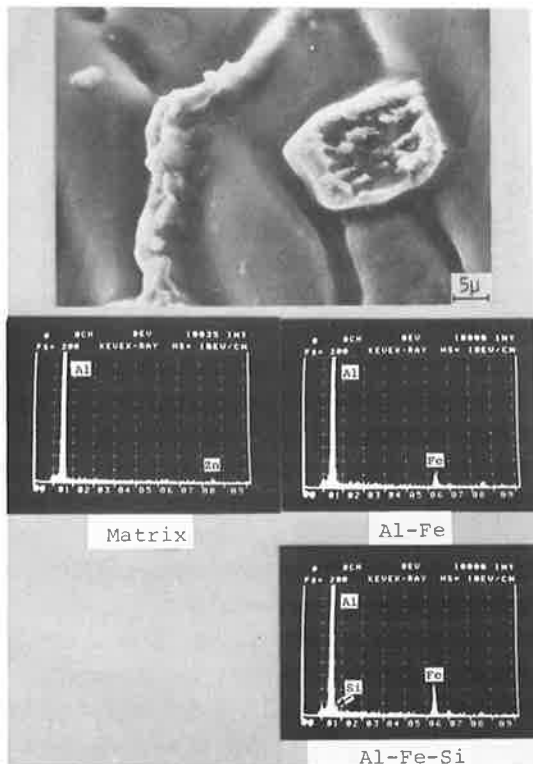

Fig. 16 SEM microphotograph of cracked surface in ring-casting and EDX results of eutectics for Al-2% Zn.

eutectic compounds observed are also shown. In the case of Al-2% Zn without Mg, two types of eutectic compounds, that is, mainly Al-Fe (estimated as Al_3Fe) and sometimes Al-Fe-Si (estimated as $\text{Fe}_3\text{Si}_3\text{Al}_{12}$ or $\text{Fe}_2\text{Si}_2\text{Al}_9$) were observed. This is due to Fe and Si contained as impurities. Zinc was detected as the solid solution in Al. According to Al-Fe-Si ternary phase diagram⁹⁾ eutectic temperature of Al_3Fe and α (Al) is 629°C which almost agrees with solidus temperature measured in Fig.14

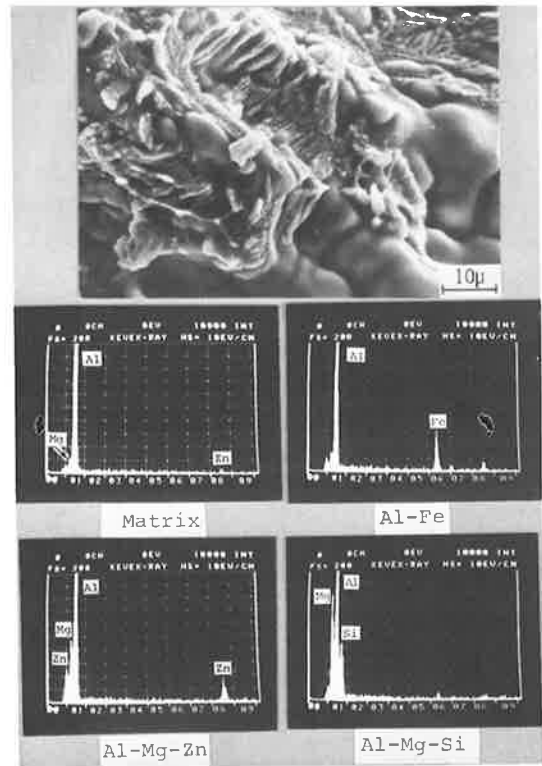

Fig. 17 SEM microphotograph of cracked surface in ring-casting and EDX results of eutectics for AL-2% Zn-1% Mg.

and is lowered to 578°C by the existence of Si. When magnesium was contained, Al-Mg-Zn eutectic compounds were began to be observed at more than 1% Mg content as shown in Figs. 17 and 18 for 1% and 5% Mg contents, respectively. At the same time Al-Mg-Si compound was also sometimes observed. According to the Al-Zn-Mg ternary phase diagram⁹⁾, Al-Mg-Zn eutectic compounds are considered to be τ which made binary eutectic with α below 490°C or β coexisting with τ and α by making ternary eutectic at 450°C . Al-Mg-Si eutectic compounds is considered to be eutectic of Mg_2Si and α whose eutectic temperature is 595°C and ternary eutectic reaction of $\alpha - \beta - \text{Mg}_2\text{Si}$ occurs at 450°C if sufficient amount of Si is contained.

These results shows that at more than 1% Mg, the solidus temperature already reached to below 490°C and to 450°C at lowest. The existence of these sub-solidus due to non-equilibrium solidification is also reported in Al-Zn-Mg alloy with small Zn and Mg contents¹⁰⁾.

Consequently, taking both results of thermal analysis and SEM observation with EDX into considerations, solidification temperature range of Al-2% Zn alloy are decided as shown in Fig. 19 for various Mg content.

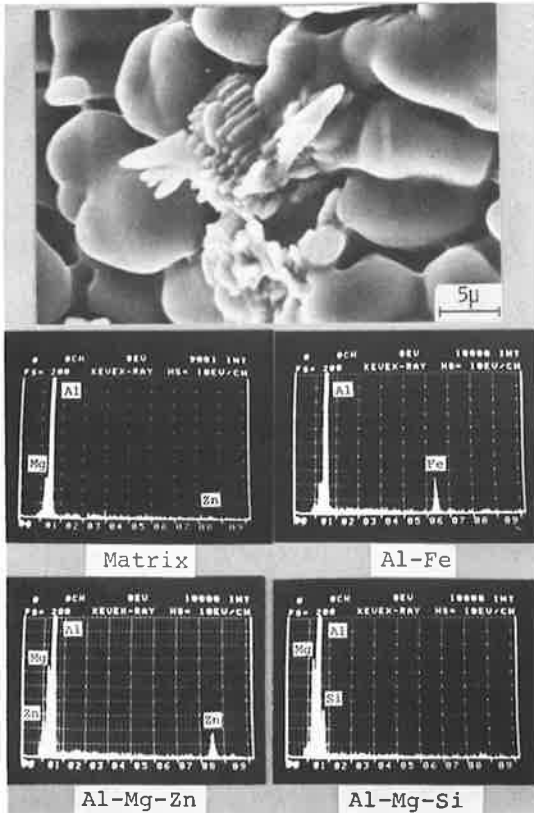

Fig. 18 SEM microphotograph of cracked surface in ring-casting and EDX results of eutectics for Al-2% Zn-5% Mg.

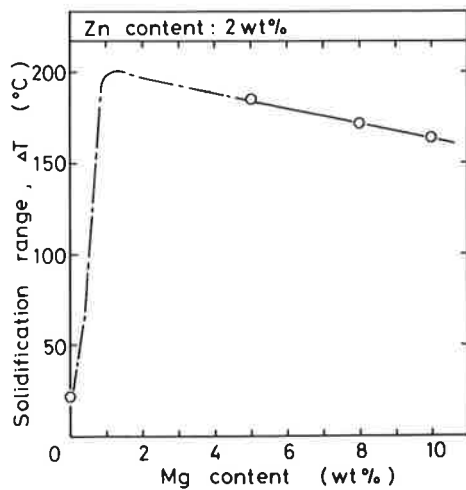

Fig. 19 Effect of Mg content on solidification temperature range.

showing combined effects of magnesium on various factors affecting on cracking susceptibility, which is as follows; i) Without Mg, small dihedral angle (d) and large grain size (c) caused comparably high cracking susceptibility (a) even having narrow solidification temperature range (b). ii) At 1% Mg content, in addition to small dihedral angle (d) and large grain size (c), very wide solidification temperature range (b) increased susceptibility for solidification cracking. iii) At more than 2% Mg content, cracking susceptibility decreased mainly due to the increase in dihedral angle as the increase in Mg content. In addition to the above, the decrease in grain size and in solidification temperature range is beneficial to lower the cracking susceptibility. Moreover, the increase in amount of eutectic compounds is also beneficial. Consequently, it is considered that cracking susceptibility decreased due to combined effect of these factors as the increase in Mg content.

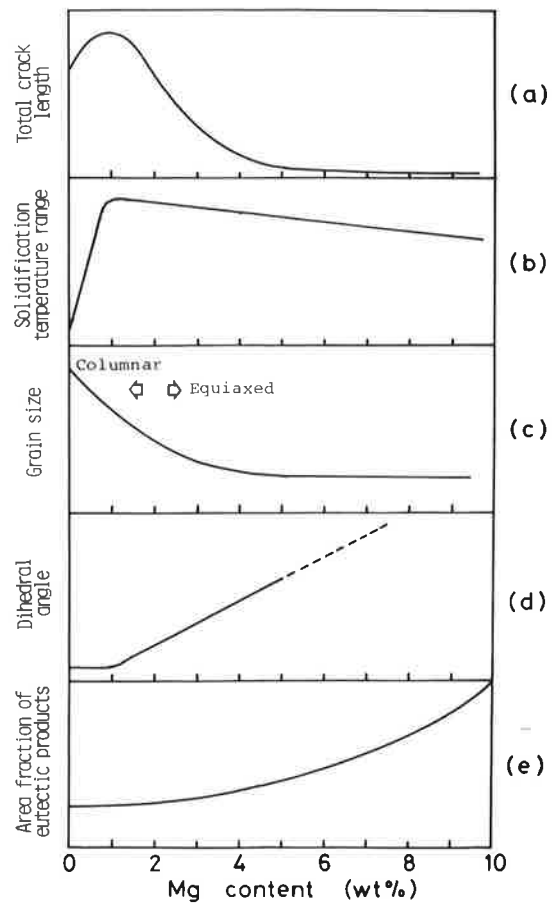

Fig. 20 Schematic diagram showing combined effects of magnesium on cracking susceptibility evaluated by ring-cast cracking test.

From the results of discussions in the above the conclusive estimations are drawn. The explanation has been attempted for the reason why solidification crack susceptibility was changed depending on Mg content by using the schematic diagram in Fig. 20 (a), (b), (c), (d) and (e)

3.2 Effect of new welding wire on cracking susceptibility in GMA welds of 7N01

Figure 21 shows the typical appearances of crater cracking of 7N01 with 7N11, 5356 and Al-7% Mg welding wires and their higher magnification photographs in lower part of Fig. 21. The large Y-shaped crater cracks were observed in the case of 7N11 and 5356. On the contrary, only very short fine cracks were observed at the center of the weld crater with Al-7% Mg welding wire. The lengths of these crater cracks were measured and the results are shown in Fig. 22 for the various welding conditions.

The cracking susceptibility can be arranged as the next order for each welding condition, that is, 7N11 > 5356 > Al-7% Mg.

Figure 23 shows effect of Mg content to cracking susceptibility, where Zn content is also indicated as the number affixed to the mark. It is clearly seen that cracking susceptibility is almost linearly decreased as the increase in Mg content of weld metal for each welding condition almost independent to Zn content, though data were scattered to some extent within a hatched range since cooling rate and restraint of weld metal during solidification were changed with the difference in welding condition. In case of Al-7% Mg welding wire, Mg content of weld metal reached to more than 5% which coincides with the recommended compositional range. In case of 5356 welding wire in low welding heat input of 220~230 amp, cracking susceptibility became comparably low, because Mg content reached

to about 4.5%. However, in this welding condition, insufficient penetration in groove occurred.

Nextly, the effects of these welding wires on the cracking susceptibility in the weld metal at the weld starting zone were examined by the VDR cracking test. Results are shown in Fig. 24 where the critical deformation rate for crack initiation \dot{D}_{CI} is indicated in the bold lines drawn at the lowest deformation rate required to cause cracking. The \dot{D}_{CI} of Al-7% Mg welding wire is 0.49 mm/sec, which is a little higher than that of 5083 weld metal with 5183 welding wire, 0.44 mm/sec. On the contrary, 5356 and 7N11 are much low, that is, 0.27 and 0.17 mm/sec, respectively. The values of the \dot{D}_{CI} of these welding wires for 7N01 are arranged as the next order, that is, Al-7% Mg > (5083 with 5183 welding wire) > 5356 > 7N11. The effect of Mg content in weld metal to \dot{D}_{CI} was also examined and the result is shown in Fig. 25.

Magnesium in weld metal almost linearly increased the \dot{D}_{CI} , which was independent of Zn content. These beneficial effect of magnesium, which was emphasized at more than 5%, for the improvement of the resistance to solidification cracking during welding successfully agreed with the results expected in 3.1.

Consequently, as the results of GMA weld crater cracking test and the VDR cracking test, it is quite clear that Al-7% Mg alloy is an excellent welding wire to improve the resistance to solidification cracking in weld bead and crater in GMA welding of 7N01.

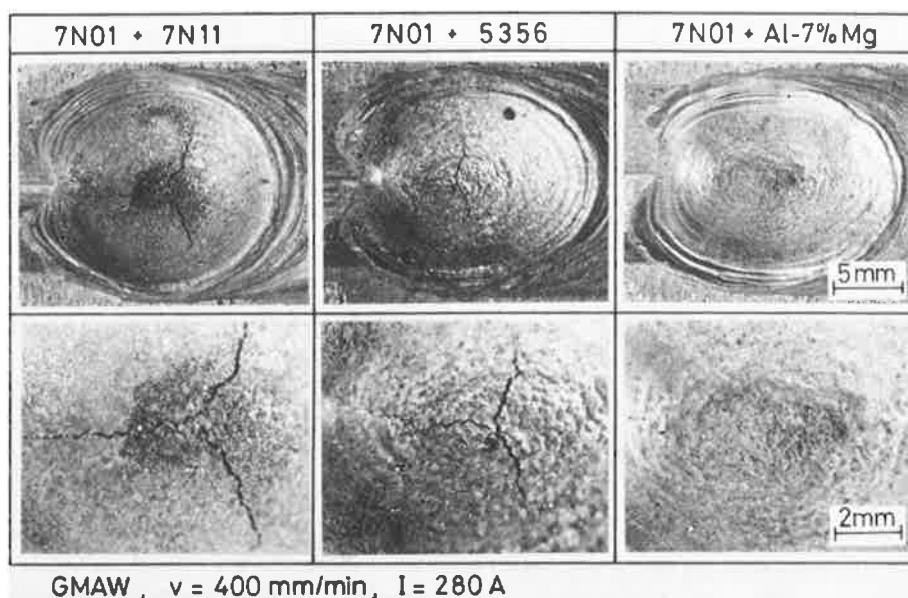

Fig. 21 Typical appearances of crater cracking occurred in GMA weld crater (base metal : 7N01, welding wire : 7N11, 5356 and Al-7% Mg)

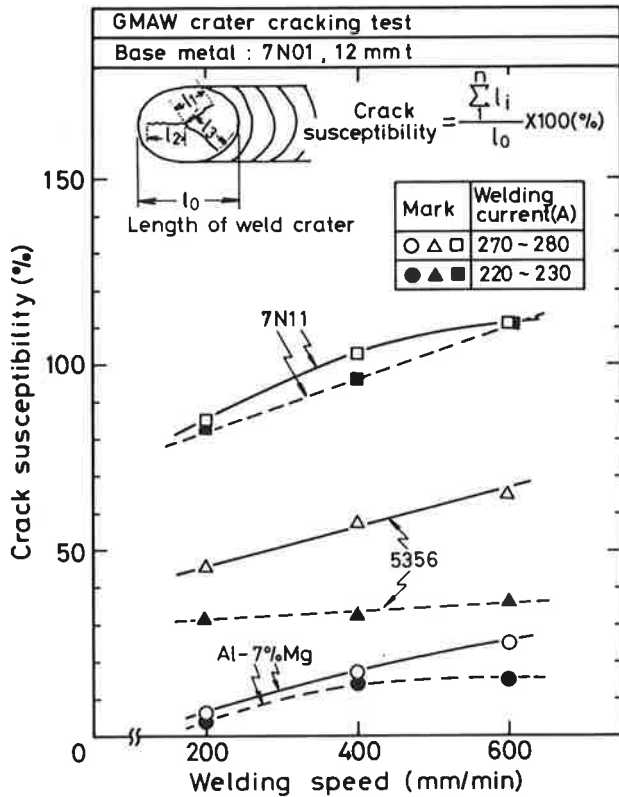

Fig. 22 Crack susceptibility of GMAW crater cracking for various welding wires in three welding speeds.

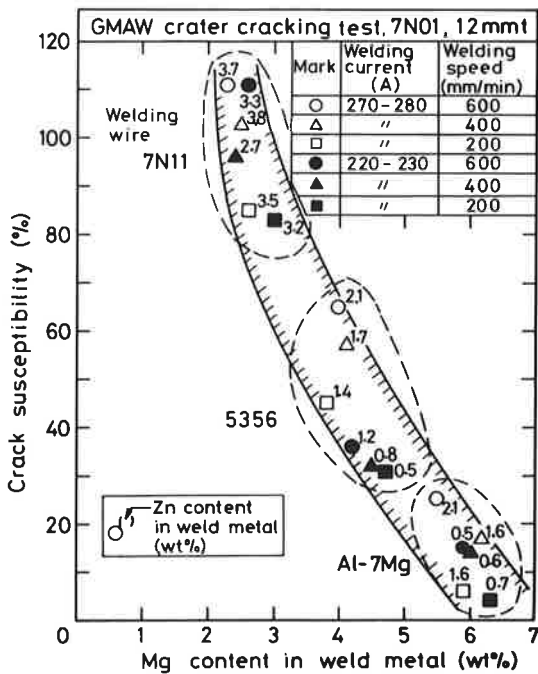

Fig. 23 Effect of Mg content in weld metal on cracking susceptibility evaluated by GMAW crater cracking test.

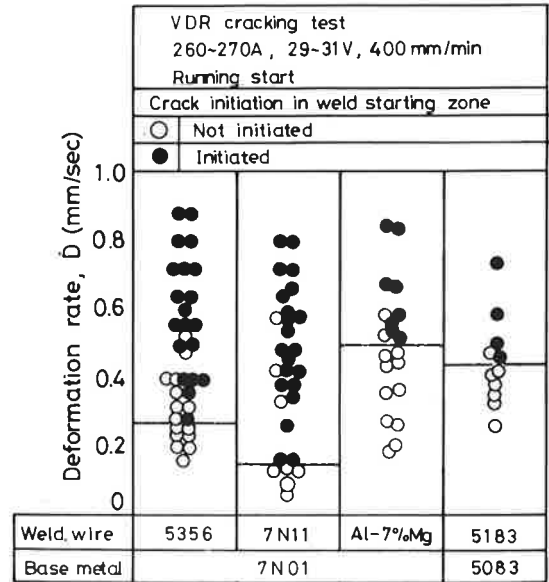

Fig. 24 Critical deformation rate, \dot{D}_{CI} for initiation of solidification cracking at weld starting zone evaluated by the VDR cracking test.

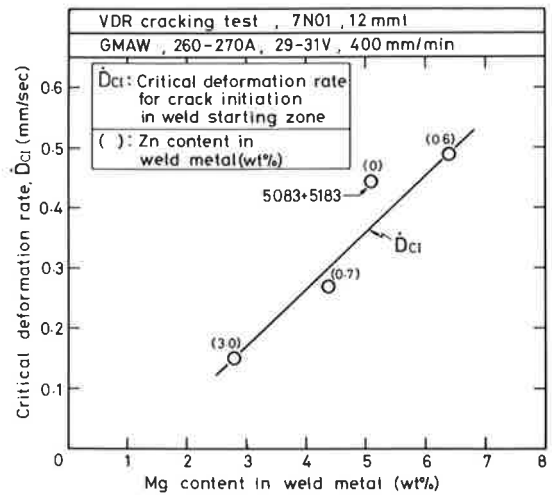

Fig. 25 Effect of Mg content in weld metal on the \dot{D}_{CI} .

4. Conclusions

The fundamental investigations on the effects of Mg and Zn contents in the weld metal in Al-Zn-Mg system on the solidification cracking susceptibility have been carried out with ring-cast cracking test and GTA spot weld crater cracking test. Then, the cracking susceptibility of new welding wire, Al-7% Mg, made experimentally in this study has been examined with GMA crater cracking test and the VDR cracking test in comparison with some

commercial welding wires. The main conclusions obtained are as follows:

- 1) Solidification crack susceptibility in Al-Zn-Mg system mainly depended on the Mg content within the range of less than 3% Zn content. It showed the maximum value at about 1% magnesium but decreased drastically as the increase in Mg content at more than 3%.
- 2) Zinc was less effective on the cracking susceptibility than magnesium within the range of 3% Zn content, but in more content it markedly increased the cracking susceptibility.
- 3) More than 5% magnesium is needed to be contained in the weld metal in order to lower the cracking susceptibility to the same level of that of 5083 when the Zn content is less than 3%.
- 4) New Al-7% Mg welding wire has proved to be an excellent welding wire for the improvement of the resistance to the solidification cracking in the weld bead and crater during GMA welding of 7N01 Al-Zn-Mg alloy.
- 5) It seems that beneficial effect of high Mg content on solidification crack susceptibility mainly results in the

combined effects of making fine grains and increasing the dihedral angle and amount of eutectics during solidification.

References

- 1) K.P. Mudrack : Schweissen und Schneiden, Vol. 12 (1960), 45-55.
- 2) J.H.Dudas et al : W.J., 1966, June, 241s-249s.
- 3) Y.Miyanaga : Master thesis of Osaka Univ., 1980 (in Japanese)
- 4) A.R.E.Singer et al : J. of the Institute of Metals, Vol. 73 (1947), 273 - 284.
- 5) F.Matsuda, H.Nakagawa, K.Nakata and H.Okada : Trans. of JWRI, Vol. 8 (1979), No. 1, 85 - 95.
- 6) W.Patterson et al : ALUMINIUM, Vol. 35 (1959), 124 - 130.
- 7) Z.Buray : Schweissttechnik, Vol. 12 (1962), 157 - 163.
- 8) Lees, D.C.G. : J. of the Institute of Metals, Vol. 72 (1946), 343 - 364.
- 9) Metals Handbooks, 8th edition, Vol. 8 (1973).
- 10) K.Koike : J. of Japan Institute of Light Metals, Vol. 30 (1980), No. 8, 442 - 448 (in Japanese).